

**Overview**

- Dimmable constant voltage
- Active power factor correction
- Compliant to IEC623860-101,102,207
- 2-100% Dimming range
- Nominal life 50,000 hours
- 5-year guarantee
- Australia/New Zealand Certification



**Ordering Information**

**Part Number:**

**HDL-CV-09-24-HPF**



**Electrical**

Input:

- 240V, 50Hz
- Power Factor >0.95 @ full load
- Flex: 1M 3 core c/w plug top (option)
- THD: <20%
- Dielectric strength: 3750V
- Inrush current: tba
- Earth leakage current: tba
- MCB B curve: (6A, 10A, 16A) tba
- MCB C curve: (6A, 10A, 16A) tba

**Electrical**

Output:

- 9W, 24V, 375mA
- ≥ 80% efficiency @ full load
- 2-100% dimming range
- Screw terminals
- Wire size (mm): 0.5 to 3.0
- Screw torque (Nm): 0.45

**Mechanical**

- Polycarbonate UL94-VO
- (rated for low smoke and halogen free)
- Dimensions (mm): 84 x 29 x 20
- Weight (grammes): 50

## PRODUCT DATASHEET

### IP20 DALI Indoor Series

### 9W 24V CONSTANT VOLTAGE HPF

#### Line Drawing

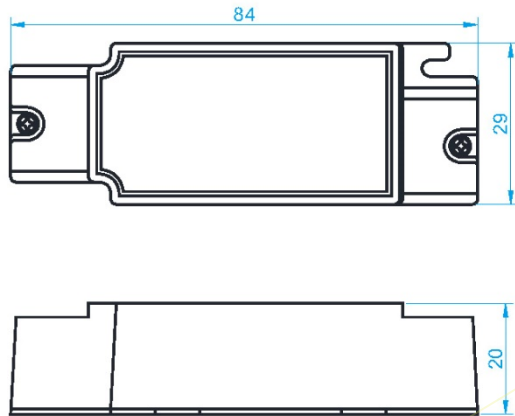

#### Protection

- Class II
- IP20 protection rating
- Fully isolated (input/output)
- Short circuit with auto reset
- Over-voltage with auto reset
- Over-temperature with auto reset

#### Wiring Diagram

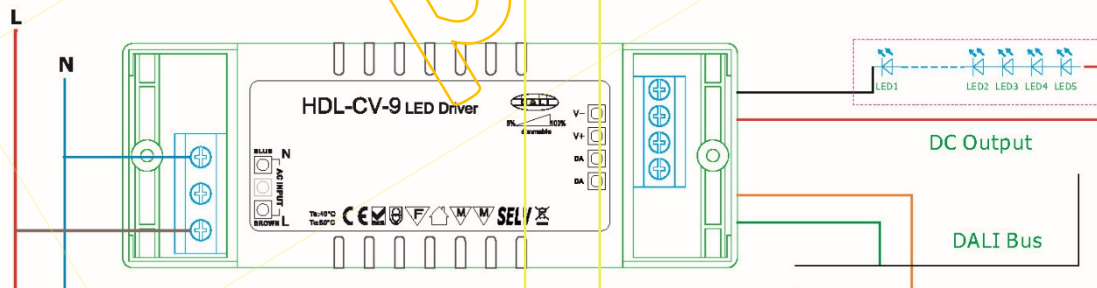

#### Thermal

- Ta rating -30°C to +45°C

#### Safety:

- RCM Mark applied