

Overview

- Dimmable constant voltage
- Active power factor correction
- Compliant to IEC623860-101,102,207
- 2-100% Dimming range
- Nominal life 50,000 hours
- 5-year guarantee
- Australia/New Zealand Certification



Ordering Information

Part Number:

HDL-CV-30-24-HPF



Electrical

Input:

- 240V, 50Hz
- Power Factor >0.95 @ full load
- Flex: 1M 3 core c/w plug top (option)
- THD: <20%
- Dielectric strength: 3750V
- Inrush current: tba
- Earth leakage current: tba
- MCB B curve: (6A, 10A, 16A) tba
- MCB C curve: (6A, 10A, 16A) tba

Electrical

Output:

- 30W, 24V, 1500mA
- ≥ 85% efficiency @ full load
- 2-100% dimming range
- Screw terminals
- Wire size (mm): 0.5 to 3.0
- Screw torque (Nm): 0.45

Mechanical

- Polycarbonate UL94-VO
- (rated for low smoke and halogen free)
- Dimensions (mm): 133 x 46 x 24
- Weight (grammes): 138

Line Drawing

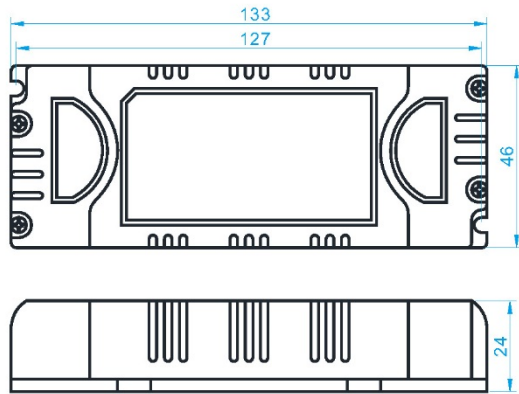

Protection

- Class II
- IP20 protection rating
- Fully isolated (input/output)
- Short circuit with auto reset
- Over-voltage with auto reset
- Over-temperature with auto reset

Wiring Diagram

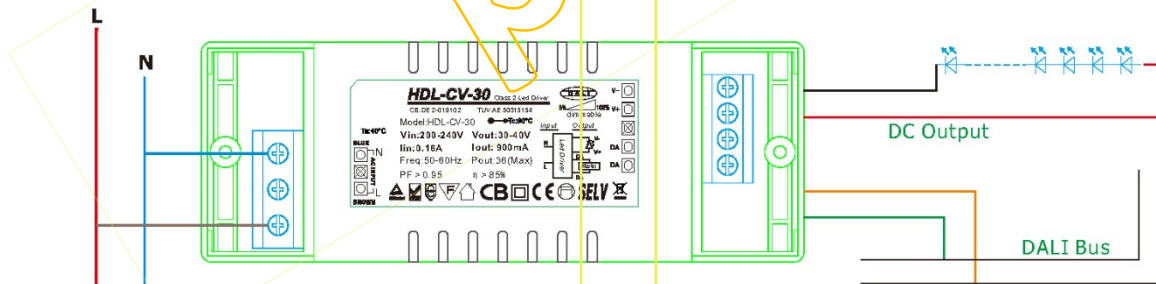

Thermal

- Ta rating -30°C to +45°C

Safety:

- RCM Mark applied