

Overview

- Dimmable constant voltage
- Leading and trailing edge dimmers
- Dimming range 2 to 100 %
- Active power factor correction
- Nominal life 50,000 hours
- 5-year guarantee
- Australia/New Zealand Certification



Ordering Information

Part Number:

DR-CV-20-24-HPF



Electrical

Input:

- 240V, 50Hz
- Power Factor >0.95 @ full load
- THD: <20%
- Dielectric strength: 3750V

Output:

- 20W, 24V, 830mA
- ≥ 85% efficiency @ full load
- 2-100% dimming range

Mechanical

- Polycarbonate UL94-VO
- (rated for low smoke and halogen free)
- Dimensions (mm): 107 x 47 x 22
- Weight (grammes): 100
- Screw terminals
- Wire size (mm): 0.5 to 3.0
- Screw torque (Nm): 0.45

Protection

- Class II
- IP20 protection rating
- Fully isolated (input/output)
- Short circuit with auto reset
- Over-voltage with auto reset
- Over-temperature with auto reset

Safety:

- RCM Mark applied

PRODUCT DATASHEET

IP20 TRIAC Indoor Series

20W 24V CONSTANT VOLTAGE HPF

Line Drawing

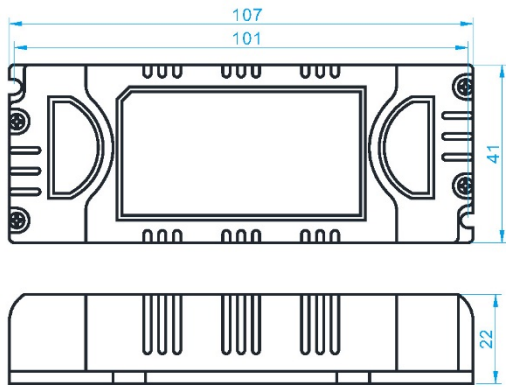

Wiring Diagram

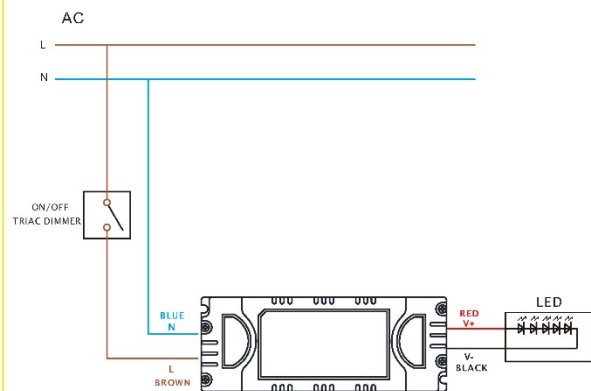

Thermal

- Ta rating -30°C to +45°C